

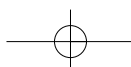

RELAYS

CONTENTS

MINIATURE RELAYS, TYPE PT	Page 224
MULTIMODE RELAYS, TYPE MT	Page 228
POWER RELAYS, TYPE RM	Page 231
POWER PCB RELAYS, TYPE RT	Page 234
SLIM PCB RELAYS, TYPE SNR	Page 236



MINIATURE RELAYS, TYPE PT

MINIATURE RELAY, TYPE PT



MINIATURE RELAY PT

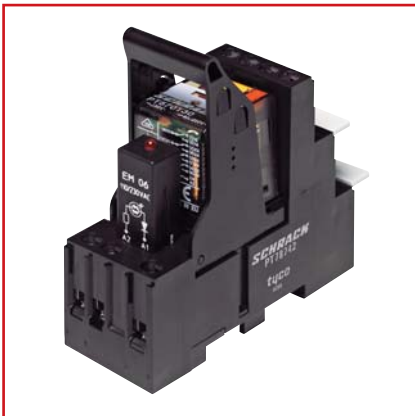

PT78742

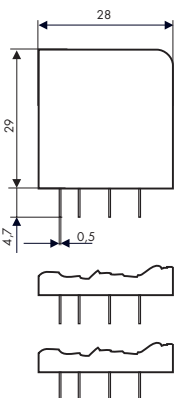
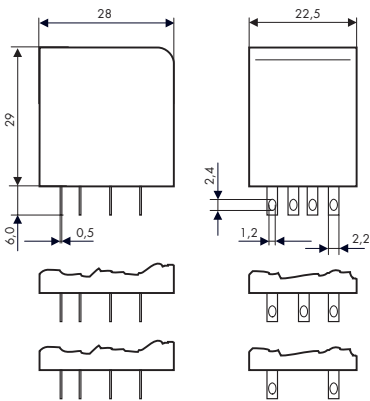

SCHRACK-INFO

- Socket comes with solder or PCB terminals
- Plug-in sockets with screw-type terminals
- LED and Protection modules
- With a switching current of 6 A, the 4-pole version offers switch cabinets a power reserve of 20% compared with comparable relays. Its reduced height means space in the switch cabinet can be used more efficiently.
- Can be used universally in automation and control
- 2, 3 or 4 C/O contacts
- Switching performance of up to 3000 VA
- Height 29 mm
- Cadmium-free contact material
- Mechanical and electrical indicator
- Push-to-test button, accidental contact-proof, various lock options
- White label
- RoHS compliant (directive 2002/95/EC)

SUPPLEMENTAL TECHNICAL DATA

- Contact data

Nr. & type of contacts	2C/O / 3C/O / 4C/O
Contact design:	Single contacts:
Switching current:	12 A/10 A/6 A
Rated voltage:	250 V~/250 V~/250 V~
Max. switching voltage:	440 V~/440 V~/440 V~
Max. switching capacity:	3000 VA/2500 VA/1500 VA
Peak inrush power:	24 A/20 A/12 A
Contact material:	AgNi 90/10, AgNi 90/10 htv

• Contact rating			
Type	Load	Operations	Certification
PT570	6 A, 250 V~, at C/O	1x10 ⁵	VDE 0435

- Coil data

Rated voltage	DC coil:	6 - 220 V-
	AC coil:	6 - 230 V~
Rated power	DC coil:	typ. 0,75 W
	AC coil:	typ. 1,0 VA
Operating range/pull-in category:		2/b
Operating range, AC coil 60 Hz at 70 °C:		90 - 110 % U _{rated}

TIPS & TRICKS

The PT series miniature relay is predominantly used in heating and elevator control systems, machines and process plant engineering.

RANGE OF APPLICATION

Can be used universally in automation and control

ACCESSORIES

- Sockets come with solder or PCB terminals
- Plug-in sockets with screw-type terminals
- LED and Protection modules

PACKAGING

All PT miniature relays come with a new user-friendly cardboard packaging in sets of 10 pieces.

MINIATURE RELAYS, TYPE PT

MINIATURE RELAY, TYPE PT – continued



MINIATURE RELAY PT

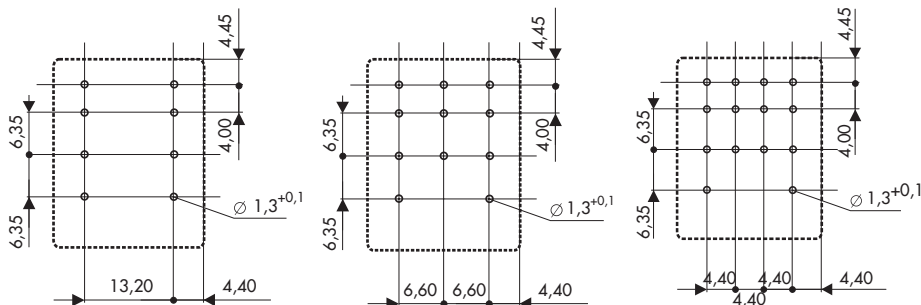

NOTE

Technical details available upon request for approved types.

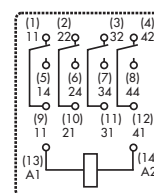
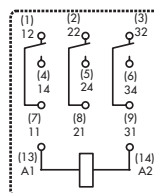
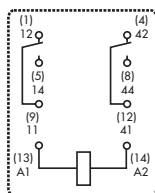

RATED COIL VOLTAGE	ORDER NO.
WITH 2 C/O CONTACTS, 12 A AND DC AND AC COILS	
24 V DC	PT270024
110 V DC	PT270110
24 V AC	PT270524
230 V AC	PT270730
WITH 3 C/O CONTACTS, 10 A AND DC AND AC COILS	
24 V DC	PT370024
125 V DC	PT370125
24 V AC	PT370524
230 V AC	PT370730
WITH 4 C/O CONTACTS, 6 A AND DC AND AC COILS	
6 V DC	PT570006
12 V DC	PT570012
12 V DC with gold-plated contacts	PT580012
24 V DC	PT570024
24 V DC with LED	PT570L24
24 V DC with gold-plated contacts	PT580024
48 V DC	PT570048
60 V DC	PT570060
110 V DC	PT570110
110 V DC with gold-plated contacts	PT580110
125 V DC	PT570125
220 V DC	PT570220
220 V DC with LED	PT570N20
220 V DC with gold-plated contacts	PT580220
6 V AC	PT570506
12 V AC	PT570512
24 V AC	PT570524
24 V AC with LED	PT570R24
24 V AC with gold-plated contacts	PT580524
48 V AC	PT570548
60 V AC	PT570560
115 V AC	PT570615
230 V AC	PT570730
230 V AC with LED	PT570T30
230 V AC with gold-plated contacts	PT580730
230 V AC	PT571730

MINIATURE RELAYS, TYPE PT

PT PLUG-IN SOCKETS WITH SCREW-TYPE TERMINALS

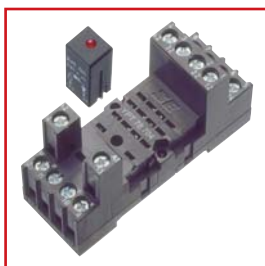

YPT78704



YMFDG230



PT78742

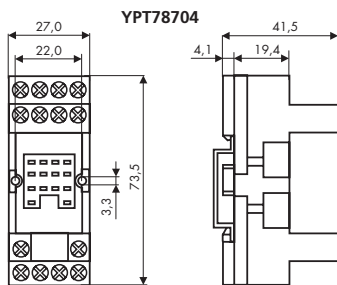
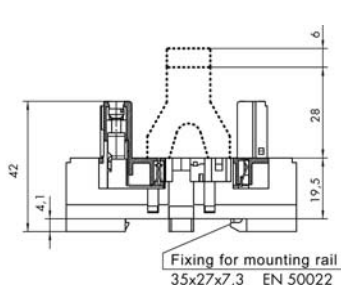

YPT78704

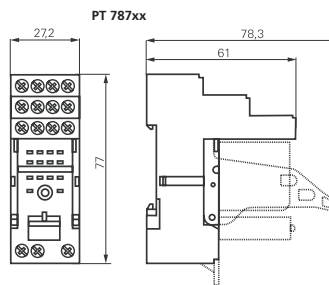

PT 787xx

50489-AAE

DESCRIPTION	ORDER NO.
Plug-in socket, 4-pole, 6 A	YPT78704
Plug-in socket, 4-pole, 6 A with protection diode 1N4007	YPT78110
Plug-in socket, I/O, 4-pole, 6 A	PT78742
Plug-in socket, 3-pole, 10 A	YPT78703
Plug-in socket, 2-pole, 12 A	YPT78702
Plug-in socket, I/O, 2-pole, 12 A	PT78722

ACCESSORIES FOR PLUG-IN SOCKETS WITH SCREW-TYPE TERMINALS

DESCRIPTION	ORDER NO.
Marking tag	YPT16040
Retaining clip	YPT16016
Marking tag for PT787xx	PT17040
Retaining clip for PT787xx	PT17021
Metal retaining clip for plug-in sockets	PT28800

LED- AND PROTECTION MODULES FOR PLUG-IN SOCKETS WITH SCREW-TYPE TERMINAL AND SCREWLESS TERMINALS

DESCRIPTION	ORDER NO.
Red LED module, 6...24 VDC w/ protective diode 1N4007, A1+	YMLRD024-A
Red LED module, 6... 24V DC w/ protective diode 1N4007, A1-	YMLRD024
Green LED module, 6...24 VDC w/ protective diode 1N4007, A1+	YMLGD024
Green LED module, 6...24 VAC/DC	YMLGA024
Red LED module, 6...24 VAC/DC	YMLRA024
Red LED module, 110...230 VAC	YMLRW230
Green LED module, 110...230 VAC	YMLGW230
Protective diode module 6...230 VDC, A1+	YMFDG230
Red RC module, 6...24 VAC/DC	YMRCW024
RC module, 110...230 VAC	YMRCW230
Varistor module 24V AC	YMWAV024
Varistor module 230V AC	YMWAV230

MINIATURE RELAYS, TYPE PT

PT PLUG-IN SOCKETS WITH SCREWLESS TERMINALS

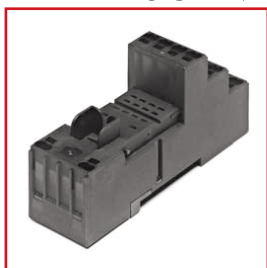

PT7874P

DESCRIPTION	ORDER NO.
Screwless, Plug-in socket, 4-pole, 6 A	PT7874P

ACCESSORIES FOR PLUG-IN SOCKETS WITH SCREWLESS TERMINALS



PT17021

DESCRIPTION	ORDER NO.
Plastic retaining clip, relay height 29/35 mm	PT17021
Metall retaining clip PT, relay height 29 mm	PT28800
Marking tag	PT17040
Sumper Link	PT170P1

PT SOCKETS

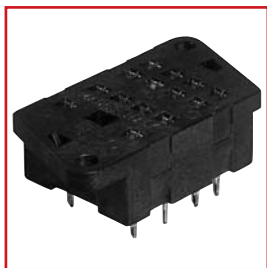

PT78600

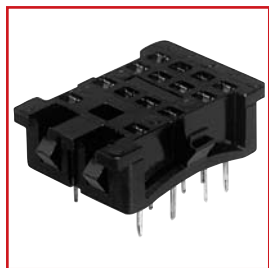

PT78601

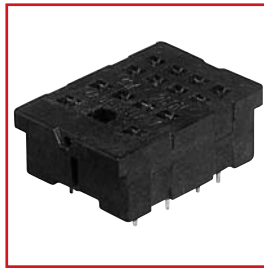

PT78604

DESCRIPTION	ORDER NO.
Plug-in socket with screw-type terminals, 4-pole, 6 A	PT78600
Plug-in socket for 4-pole PCB relay, 6 A	PT78604
Plug-in socket with solder terminals, 4-pole, 6 A	PT78601
PCB socket, 3-pole, 10 A	PT78603
Plug-in socket for 2-pole PCB relay, 10 A	PT78602

ACCESSORIES FOR PT SOCKETS

DESCRIPTION	ORDER NO.
Metal retaining clip for PCB sockets	PT28802

MULTIMODE RELAYS, TYPE MT

MULTIMODE RELAY, TYPE MT



MULTIMODE RELAY MT



MT326024/MTMF0W00

SCHRACK-INFO

- 2 C/O or 3 C/O contacts
- Cadmium-free contact material
- Mechanical indicator as standard
- Electrical indicator
- New test system with front operated fingerprotected push-to-test button and integral locking test tab.
- Safe from contact
- Integrated locking tab in cap
- Push-to-test button at front
- White marking label
- RoHS compliant (directive 2002/95/EC)

- DC coil:
The pull-in voltage is equal to 0,75 x rated voltage.
The release voltage is equal to 0.10 x rated voltage.
- AC coil:
The pull-in voltage is equal to 0.80 x rated voltage.
The release voltage is equal to 0.40 x rated voltage.

TECHNICAL DATA

The MT series miniature relay is predominately used in heating and elevator control systems, machines and process plant engineering.

ACCESSORIES

- Screw-type sockets
- Protection modules
- Plug-in sockets

NOTE

Technical details available upon request for approved types

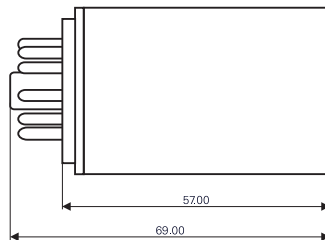
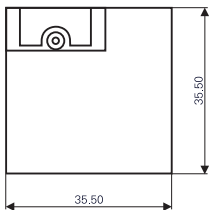
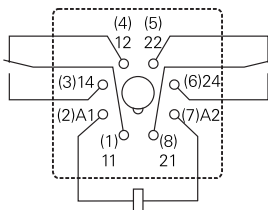
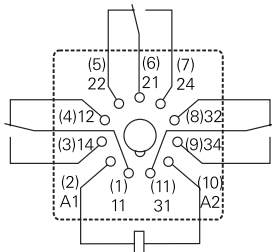

MULTIMODE RELAYS, TYPE MT

MULTIMODE RELAY, TYPE MT – continued

COIL VOLTAGE	DIM. (WxHxD) mm	ORDER NO.
WITH 2 C/O CONTACTS, 10A, 8-POLE, DC COIL		
12 V	35,5x35,5x69	MT221012
24 V	35,5x35,5x69	MT221024
48 V	35,5x35,5x69	MT221048
110 V	35,5x35,5x69	MT221110
220 V	35,5x35,5x69	MT221220
WITH 3 C/O CONTACTS, 10A, 11-POLE, DC COIL		
6 V	35,5x35,5x69	MT321006
12 V	35,5x35,5x69	MT321012
24 V	35,5x35,5x69	MT321024
24 V with gold-plated contacts	35,5x35,5x69	MT331024
24 V with prot. diode	35,5x35,5x69	MT3210C4
48 V	35,5x35,5x69	MT321048
60 V	35,5x35,5x69	MT321060
110 V	35,5x35,5x69	MT321110
220 V	35,5x35,5x69	MT321220
24 V with LED and prot. diode	35,5x35,5x69	MT3230C4
110 V with LED	35,5x35,5x69	MT323110
60 V with LED	35,5x35,5x69	MT323060
48 V with LED	35,5x35,5x69	MT323048
24 V with LED	35,5x35,5x69	MT323024
220 V with LED	35,5x35,5x69	MT323220
WITH 2 C/O CONTACTS, 10A, 8-POLE, AC COIL		
6 V	35,5x35,5x69	MT226006
12 V	35,5x35,5x69	MT226012
24 V	35,5x35,5x69	MT226024
48 V	35,5x35,5x69	MT226048
115 V	35,5x35,5x69	MT226115
230 V	35,5x35,5x69	MT226230
230 V with LED	35,5x35,5x69	MT228230
230 V with htv	35,5x35,5x69	MT236230
WITH 3 C/O CONTACTS, 10A, 11-POLE, AC COIL		
6 V	35,5x35,5x69	MT326006
12 V	35,5x35,5x69	MT326012
24 V	35,5x35,5x69	MT326024
24 V with LED	35,5x35,5x69	MT328024
48 V	35,5x35,5x69	MT326048
60 V	35,5x35,5x69	MT326060
110 V	35,5x35,5x69	MT326110
115 V	35,5x35,5x69	MT326115
115 V with LED	35,5x35,5x69	MT328115
230 V	35,5x35,5x69	MT326230
230 V with htv	35,5x35,5x69	MT336230
230 V with LED	35,5x35,5x69	MT328230
230 V with LED & htv	35,5x35,5x69	MT338230

MULTIMODE RELAYS, TYPE MT

MT PLUG-IN SOCKETS WITH SCREW-TYPE TERMINALS



YMR78700

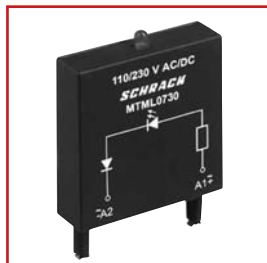

MTML0730



MTMF0W00

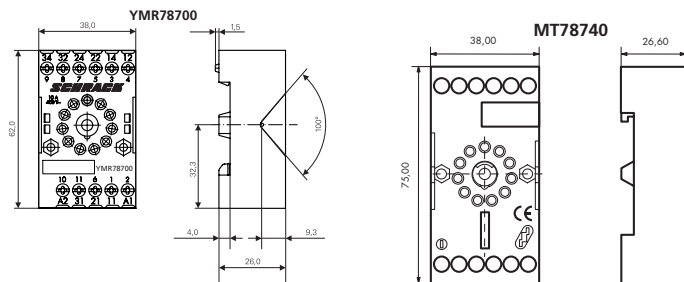

DESCRIPTION	DIM. (WxHxD) mm	ORDER NO.
11-pole screw-type socket	38x62x26	YMR78700
8-pole screw-type socket	38x62x26	YMR78701
11-pole screw-type socket with shaft for modules	38x75x26	MT78740
Metal retaining clip	-	MT28800

LED-, FUNCTION- AND PROTECTION MODULES FOR MT PLUG-IN SOCKETS MT78740

DESCRIPTION	DIM. (WxHxD) mm	ORDER NO.
Module protect. diode 1N4007	35x55x10	MTMT00A0
Module RC network, 115/240 V AC	35x55x10	MTMU0730
Module RC network, 6/24 V AC	35x55x10	MTMU0524
Module LED 24 V-/24 V~	35x55x10	MTML0024
Module LED 230 V~	35x55x10	MTML0730
Timer module/multifunction	35x55x20	MTMF0W00
Module timer module/delay ON	35x55x20	MTMZ0W00

MT PLUG-IN SOCKETS WITH SOLDER AND PCB TERMINALS



MT78612



MT78613



MT78602



MT78603

DESCRIPTION	DIM. (WxHxD) mm	ORDER NO.
8-pole plug-in socket with solder terminal	32x48x22	MT78612
11-pole plug-in socket with solder terminal	32x48x22	MT78613
8-pole plug-in socket with PCB terminal	Ø28x19	MT78602
11-pole plug-in socket with PCB terminal	Ø28x19	MT78603

POWER RELAYS, TYPE RM

POWER RELAY, TYPE RM, 1-, 2- OR 3-POLE

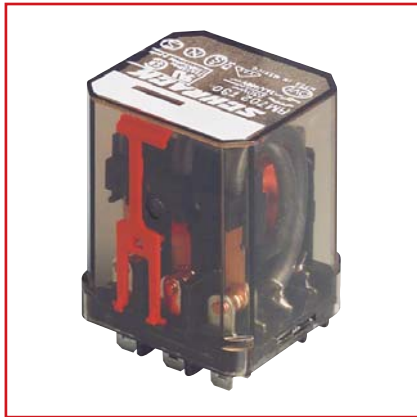

POWER RELAY RM

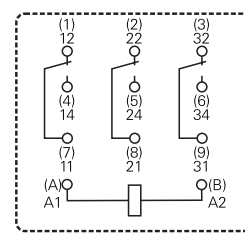
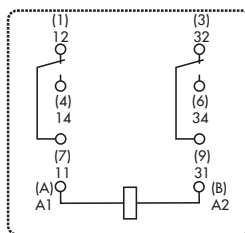
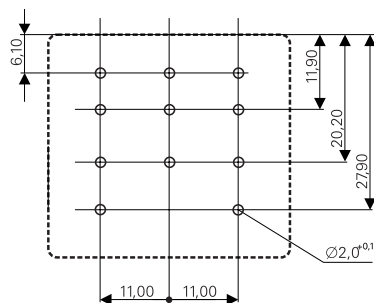
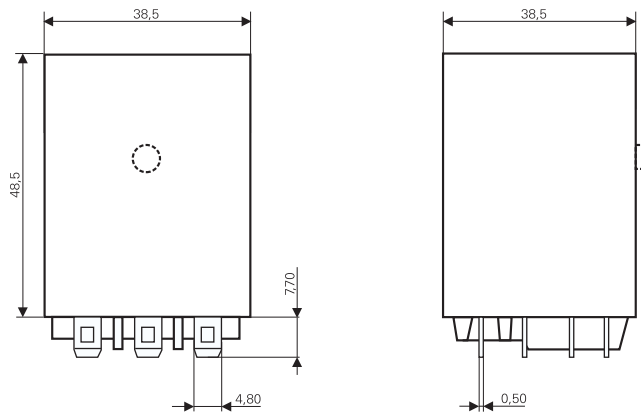

SCHRACK-INFO

- 1/2/3-pole, 10/16/25/30 A, DC and AC coils
- For plug-in and PCB terminals
- Mechanical indicator, push-to-test button
- Tab fastening, DIN rail mount
- RoHS compliant (directive 2002/95/EC)
- DC coil:
The pull-in voltage is equal to 0,75 x rated voltage.
The release voltage is equal to 0.1 x rated voltage.
- AC coil:
The pull-in voltage is equal to 0.8 x rated voltage.
The release voltage is equal to 0.4 x rated voltage.

SUPPLEMENTAL TECHNICAL DATA

- For power relay RM 5/6:
- 2 N/O or 3 N/O contacts
 - 3 mm contact gap
 - DC and AC coils
 - Push-to-test button
 - Tab fastening, DIN rail mount plug-in or PCB
 - Used in emergency power supplies, pump control systems

For power relay RM 8:

- 2 C/O contacts
- DC and AC coils
- Mechanical indicator
- Push-to-test button
- Tab fastening or DIN rail mount
- Used in cleaning machinery, heating and refrigeration control systems

For power relay RM C/D:

- 1 N/O or 1 N/O + 1 N/C
- Switching capacity up to 7200 VA
- DC and AC coils
- Push-to-test button
- Tab fastening
- Used in battery chargers, heating control systems

TIPS & TRICKS

Used for the direct control of short-circuit rotary motors, hot water storage units and off-peak current ovens. Can be used as switching relay in series devices.

NOTE

Technical details available upon request for approved types.

ACCESSORIES

Sockets

POWER RELAYS, TYPE RM

POWER RELAY, TYPE RM, 1-, 2- OR 3-POLE – continued

DC COILS

DESCRIPTION	DIM. (WxHxD) mm	ORDER NO.
1 AK, 30 A, 24 V, Faston 250	38,5x73,5x35,5	RMD05024
2 AK, 16 A, 12 V, Faston 187	38,5x56,2x35,5	RM232012-D
2 UK, 16 A, 12 V, c cap with snap-on fastening, in horizontal position	38,5x73,5x35,5	RM2380125E
2 UK, 16 A, 24 V, Faston 187	38,5x56,2x35,5	RM232024-D
2 UK, 25 A, 12 V, Faston 250	38,5x56,2x35,5	RM835012
2 UK, 25 A, 24 V, Faston 250	38,5x56,2x35,5	RM835024
2 UK, 25 A, 24 V, Faston 250 with snap-on device	38,5x56,2x44	RM839024
2 UK, 25A, 24 V, cap with snap-on fastening, horizontal position, Faston 250	38,5x56,2x35,5	RM838024
3 UK, 10 A, 12 V, Faston 187	38,5x56,2x35,5	RM332012-D
3 UK, 10 A, 24 V, Faston 187	38,5x56,2x35,5	RM332024-D
3 UK, 10 A, 110 V, Faston 187	38,5x56,2x35,5	RM332110-D
3 UK, 16 A, 12 V, Faston 187	38,5x56,2x35,5	RM732012-C
3 UK, 16 A, 24 V, Faston 187	38,5x56,2x35,5	RM732024-C
3 UK, 16A, 24 V, cap with snap-on device, horizontal position, Faston 250	38,5x66x35,5	RM738024-C
3 UK, 16A, 24 V, cap with snap-on fastening, horizontal position, Faston 250	38,5x56,2x44	RM739024-C
3 UK, 16 A, 24 V, cap with tab, Faston 250	38,5x73,5x35,5	RM735024-C
3 UK, 16 A, 60 V, Faston 187	38,5x56,2x35,5	RM732060
3 UK, 16 A, 60 V, Faston 187	38,5x56,2x35,5	RM632024-A

AC COILS

DESCRIPTION	DIM. (WxHxD) mm	ORDER NO.
3 UK, 10 A, 380 V, Faston 187	38,5x56,2x35,5	RM332880-D
3 UK, 16 A, 380 V, Faston 187	38,5x56,2x35,5	RM732880-C
2 UK, 16 A, 230 V, cap with tab, vertical position, Faston 250	38,5x73,5x35,5	RM235730-C
2 UK, 16A, 230 V, cap with snap-on fastening, Faston 250	38,5x56,2x44	RM239730-C
2 UK, 16 A, 230 V, Faston 187	38,5x56,2x35,5	RM232730-D
2 UK, 25 A, 230 V, cap with tab, Faston 250	38,5x73,5x35,5	RM8357305E
2 UK, 16A, 230 V, cap with snap-on fastening, Faston 250	38,5x56,2x44	RM839730
2 UK, 25 A, 230 V, Faston 250 with snap-on device vertical position	38,5x56,2x44	RM838730
2 UK, 25 A, 230 V, Faston 250 with snap-on device horizontal position ³	38,5x56,2x44	RM809730
2 UK, 25 A, 230V, Faston 250	38,5x73,5x35,5	RM805730
3 UK, 10 A, 24V, Faston 187	38,5x56,2x35,5	RM332524-D
3 UK, 10 A, 230V, Faston 187	38,5x56,2x35,5	RM3327305E
3 UK, 10 A, 230V, with snap-on fastening, Faston 250	38,5x66x35,5	RM338730-C
3 UK, 16 A, 24V, Faston 187	38,5x56,2x35,5	RM732524-C
3 UK, 16 A, 230V, Faston 187	38,5x56,2x35,5	RM732730
3 UK, 16 A, 230V, cap with tab, Faston 250	38,5x73,5x35,5	RM7357305E
3 UK, 1 6A, 230V, with snap-on fastening, Faston 250	38,5x66x35,5	RM738730-C
3 UK, 16 A, 230V, with snap-on fastening, Faston 250	38,5x56,2x44	RM7397305E

POWER RELAYS, TYPE RM

ACCESSORIES: SOCKETS

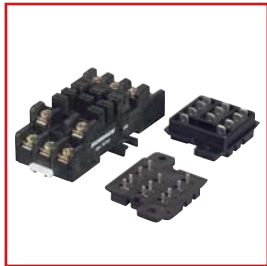

SOCKETS

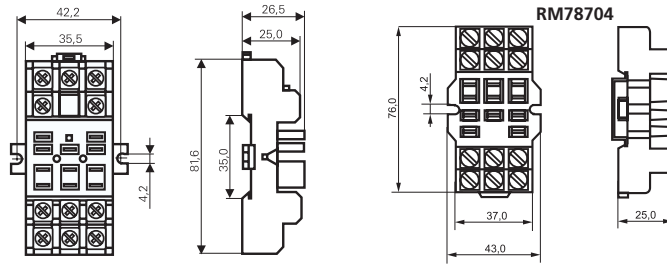

RM78700

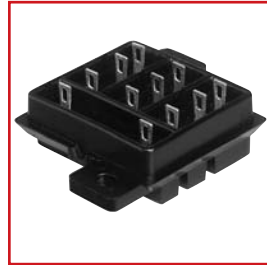

RM78701



RM78702

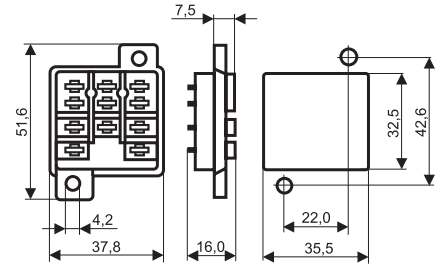

DESCRIPTION	DIM. (WxHxD) mm	ORDER NO.
Plug-in socket with screw-type terminals	49x81,6x26,5	RM78705
Plug-in socket with screw-type terminals	43x76x26,5	RM78704
Plug-in socket with screw-type terminals	37,8x51,6x16	RM78700
Plug-in socket with solder terminals	37,8x51,6x16	RM78701
Plug-in socket with PCB terminals	37,8x51,6x11,1	RM78702-A
Retaining clips for RM 78700, RM 78701, RM 78702	-	RM28802

POWER PCB RELAYS, TYPE RT

POWER PCB RELAYS, TYPE RT

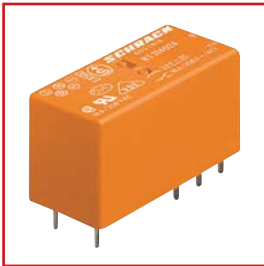

POWER PCB RELAY RT

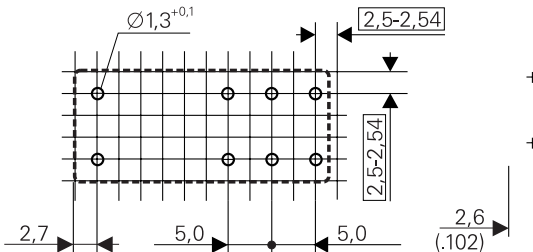
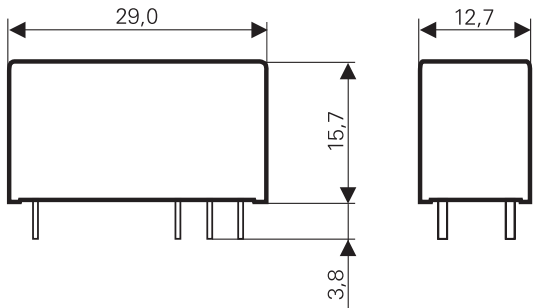

SCHRACK-INFO

- 1-pole 16 A, 2-pole 8 A
- Coil 400 mW/0,75 VA
- 5 kV/10 mm coil contact, protection class II (VDE 0700)
- Ambient temperature 85°C (DC coil)
- Low height 15,7 mm
- Gold-plated contacts available
- PCB and screw-type sockets
- Models for large make currents
- AC/DC coils
- RoHS compliant (directive 2002/95/EC)

TIPS & TRICKS

For electrical devices for control systems, for memory-programmable controls, to control contactors, servomotors, magnetic valves, hub magnets, etc.

CERTIFICATIONS

VDE 0700

NOTE

Technical details available upon request for approved types.

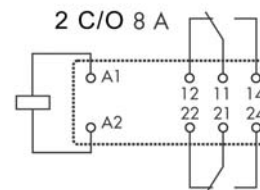
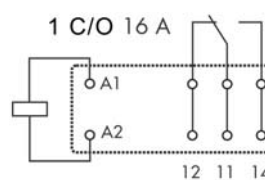

DC COILS

DESCRIPTION	DIM. (WxHxD) mm	ORDER NO.
1-pole, 5V coil, 1 C/O 16A	29x12,6x15,7	RT314005
1-pole, 6V coil, 1 C/O 16A	29x12,6x15,7	RT314006
1-pole, 16V coil, 1 C/O 16A	29x12,6x15,7	RT314012
1-pole, 24V coil, 1 C/O 16A	29x12,6x15,7	RT314024
1-pole, 48V coil, 1 C/O 16A	29x12,6x15,7	RT314048
1-pole, 110V coil, 1 C/O 16A	29x12,6x15,7	RT314110
2-pole, 5V coil, 2 C/O 8A	29x12,6x15,7	RT424005
2-pole, 6V coil, 2 C/O 8A	29x12,6x15,7	RT424006
2-pole, 12V coil, 2 C/O 8A	29x12,6x15,7	RT424012
2-pole, 24V coil, 2 C/O 8A	29x12,6x15,7	RT424024
2-pole, 48V coil, 2 C/O 8A	29x12,6x15,7	RT424048
2-pole, 60V coil, 2 C/O 8A	29x12,6x15,7	RT424060
2-pole, 110V coil, 2 C/O 8A	29x12,6x15,7	RT424110

AC COILS

DESCRIPTION	DIM. (WxHxD) mm	ORDER NO.
1-pole, 24V coil, 1 C/O 16A	29x12,6x15,7	RT314524
1-pole, 230V coil, 1 C/O 16A	29x12,6x15,7	RT314730
2-pole, 24V coil, 2 C/O 8A	29x12,6x15,7	RT424524
2-pole, 115V coil, 2 C/O 8A	29x12,6x15,7	RT424615
2-pole, 230V coil, 2 C/O 8A	29x12,6x15,7	RT424730

POWER PCB RELAYS, TYPE RT

ACCESSORIES

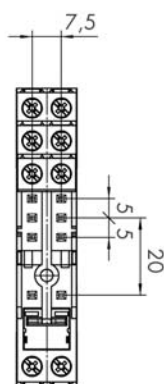
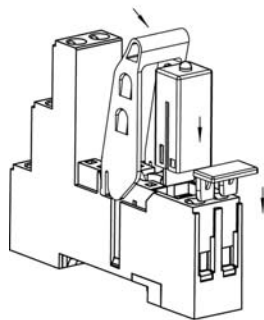

We reserve the right to apply technical changes.

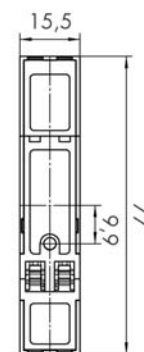
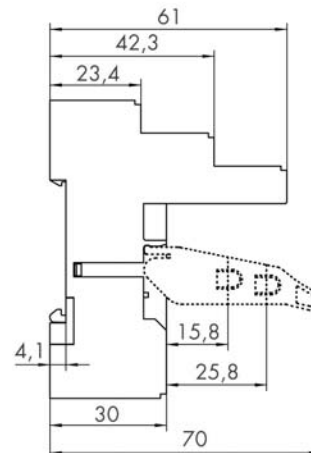

DESCRIPTION	ORDER NO.
8-pole screwless-type socket I/O 5.0 for 1- & 2-pole relay	RT7872P
8-pole screw-type socket, conventional for 1- & 2-pole relay	RT7872S
8-pole screw-type socket I/O 5.0 for 1- & 2-pole relay	YRT78626
Retaining clip	YRT16016
Marking tag	YRT16040
Red LED module, 6...24 VDC w/ protective diode 1N4007, A1+	YMLRD024-A
Red LED module, 6... 24V DC w/ protective diode 1N4007, A1-	YMLRD024
Green LED module, 6...24 VAC/DC	YMLGA024
Red LED module, 6...24 VAC/DC	YMLRA024
Red LED module, 110...230 VAC	YMLRW230
Green LED module, 110...230 VAC	YMLGW230
Protective diode module 6...230 VDC, A1+	YMF DG230
Red RC module, 6...24 VAC/DC	YMRCW024
RC module, 110...230 VAC	YMRCW230
2pole-jumper bar for RT7872P	RT170P1

SLIM PCB RELAYS, TYPE SNR

SLIM PCB RELAYS, TYPE SNR



SLIM PCB RELAY SNR

SCHRACK-INFO

- 6 A/1-pole
- Extremely slim: 5 mm
- Cadmium-free contacts
- Sensitive coil 170mW
- 4 kV coil contact, 6/8 mm clearance/creepage
- N/O version available with 8/8 mm clearance/creepage upon request
- Protection class II (VDE 0631)
- High function and packing density
- RoHS compliant (directive 2002/95/EC)

RANGE OF APPLICATION

Central and local heating control systems, extremely narrow coupling devices, interface technology, timer relays, SPSS, I/O modules.

NOTE

Technical details available upon request for approved types.

DESCRIPTION	ORDER NO.
1 C/O contact, 12 V DC	SNR03012
1 C/O contact, 24 V DC	SNR03024
1 C/O contact, 24 V DC with gold-plated contacts	SNR07024
1 make contact, 24 V DC	SNR13024

SNR PACKAGE WITH SCREW-TYPE TERMINALS OR SPRING TERMINALS, LED, RELAY AND PROTECTION CIRCUIT



SNR PACKAGE

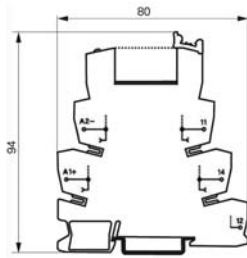

SCHRACK-INFO

- Module width only 6.2 mm
- Relay package made up of relay and socket
- Electric switch indicator (LED) as standard
- DC and AC versions
- Narrow width allows for high functional and packing depths
- Width protection circuit
- Lateral jumper bar in several colours

DESCRIPTION	ORDER NO.
SNR PACKAGE, SCREW-TYPE TERMINALS	
SNR package, screw-type terminals, 12 V DC	ST3P3LB2
SNR package, screw-type terminals, 24 V DC	ST3P3LC4
SNR package, screw-type terminals, 24 V DC, relay with gold-plated contacts	ST3P2LC4
SNR package, screw-type terminals, 115 V AC/DC	ST3P3SM5
SNR package, screw-type terminals, 230 V AC/DC	ST3P3TP0
SNR PACKAGE, SPRING TERMINALS	
SNR package, spring terminals, 12 V DC	ST4P3LB2
SNR package, spring terminals, 24 V DC	ST4P3LC4
SNR package, spring terminals, 24 V DC, relay with gold-plated contacts	ST4P2LC4
SNR package, spring terminals, 115 V AC/DC	ST4P3SM5
SNR package, spring terminals, 230 V AC/DC	ST4P3TP0

SLIM PCB RELAYS, TYPE SNR

SNR SOCKET WITHOUT RELAY

DESCRIPTION	ORDER NO.
Socket for SNR REL 12/24/48 UDC	ST3FLC4

ACCESSORIES FOR SNR PACKAGE

DESCRIPTION	ORDER NO.
Marking plate	ST37040
Spacer plate	ST36040
SNR traverse jumper bar, red, 500 mm, for STG Type	ST37001
SNR traverse jumper bar, blue, 500 mm, for STG Type	ST37002
SNR traverse jumper bar, grey, 500 mm, for STG Type	ST37003

CIRCUIT BREAKERS (MO-MC/MCCB)

TOP-TECHNIC



MC – SYTEM OVERVIEW

TOP-TECHNIC



MO – SYTEM OVERVIEW

TOP-TECHNIC



RESIDUAL CURRENT RELEASE RELAY
WITH CONVERTER